

FB6-E0108
2008. 2.18

INSTRUCTION MANUAL

TEXEL

CHEMICAL FANS

MODEL: CES-D SERIES



TEXEL-SEIKOW U.S.A., Inc.

4404 W12th St

Houston, TX 77055

TEL (1) 713-683-1505

FAX (1) 713-417-3932

Preface

Thank you for purchasing our CES Series Texel Corrosion Resistant Fan. This model, constructed mainly with FRPP (Fiberglass Reinforced polypropylene), is widely recognized as a high-performance fan featuring superior corrosion resistance to all types of corrosive gases. Handling and operation of these fans are straightforward; however, unforeseen breakdowns may occur if recommended conditions of operation and handling are not met. Please read this instruction manual carefully for proper handling and usage of Texel Corrosion Resistant Fans.

Make sure you pay attention to the following points, as failure to do so may lead to impeller damage.

Make sure that gas temperature during intake does not exceed the maximum permissible value.

Fan speed should not exceed the stated maximum speed.

Contact us if the gas to be handled is not stated on the corrosion resistance table in the catalog.

Checklist upon arrival

When the product arrives, please check the following:

- 1) Check to ensure that static pressure, gas volume, and motor record on the nameplate are correct.
- 2) Check to ensure that no components have been damaged in transit.
- 3) Check to ensure that all accessories are supplied.

Name of Parts Fig.1 Strucyual Drawing

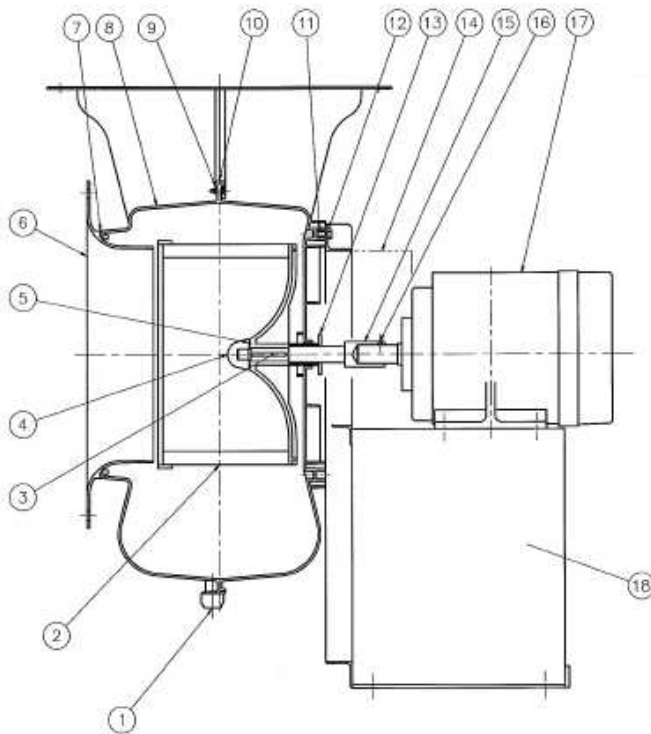

18	Bracket	SS400	1	
17	Motor	-----	1	
16	Shaft Set Screw	SUS304	1Set	
15	Shaft	S45C	1	
14	Shaft Guard	FRP	1	
13	Gas Separator	PE	1	
12	Casing Set Bolt	SUS304	1Set	
11	Insert Nut	BsBM	1Set	
10	Casing Gasket	PE	1	
9	Casing Bolt	SUS304	1Set	
8	Casing	FRPP	1	
7	Gasket	PE	1	
6	Suction Cone	FRPP	1	
5	Nut Cover O-Ring	C R	1	
4	Nut Cover	PP	1	
3	Impeller Key	S45C	1	
2	Impeller	FRPP	1	
1	Drain Plug	PE	3	PF1/2"
No.	NAME OF PART	MATERIALS	QTY	REMARK

Model: CES 151D, CES 201D

TRANSPORTATION



WARNING

Do not lift fan by the casing

To lift the fan, use the lifting hook bolts. The fan may break if lifted at parts other than the lifting hook bolts.

Note: Do not use the motor lifting bolt to lift the fan.

If the belt and bearing are covered by a single safety cover, dismantle it to gain access to the hook bolt.



WARNING

DO NOT USE FAN AS A FOOTREST

The casing and safety covers are fragile and could break leading to accident if used as a footrest.



STORAGE

STORE FAN INDOORS

Exposure of fan bearings to water or dampness for long periods may damage the bearing and the V-belts. For long-term storage, remove the belt and store it in a dry place where it is not exposed to the sun

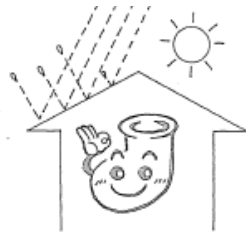

COVER FAN WITH SHEET DURING CONSTRUCTION

Bearings may be damaged if contaminated by water or dirt. Cover the entire fan with a waterproof sheet to prevent water and dirt from getting in.



INSTALLATION

MINIMUM FREE SPACE AROUND FAN: 60 cm

Create ample space around the fan to ease bearing change and maintenance and to help dissipate heat

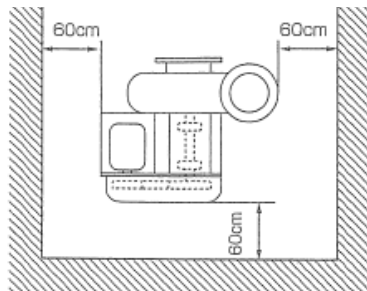

MOUNT FAN ON A SOLID FOUNDATION

A weak foundation or uneven surface will lead to abnormalities in operation and functioning.

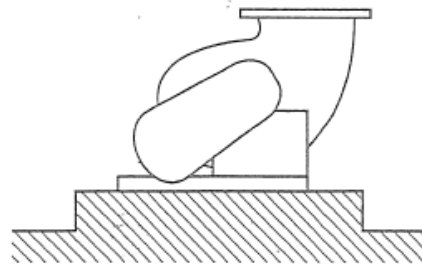

PIPING



WARNING

USE SUPPORTS, VIBRATION-PROOF JOINTS AND SHORT PIPES

The casing may deform and collide with the impeller if excess force is exerted on the fan due to piping load and vibration.

Supports and vibration-proof joints should always be used.

For easy maintenance at the suction side, attach an extension pipe at a distance of 1.5 times of distance "D". (See the picture below)

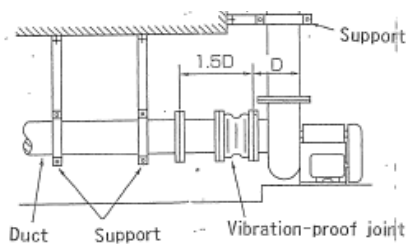

WARNING

SAFETY MEASURES FOR THE DISCHARGE OPENING

If the impeller breaks and the discharge opening is located horizontally, fragments could pierce through the duct and cause injury to personnel or damage to other equipment.

Install a protector if the discharge opening faces a passageway.

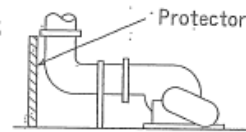

WARNING

MEASURES TO PREVENT THE SUCTION & DISCHARGE OF DEBRIS

Suction of debris when the fan is running could lead to damage of the impeller. Adopt measures to prevent debris from collision with the impeller.

ATTACH SUPPORTS TO VENTILATOR

Winds may exert strong forces on a ventilator that could damage the fan.

Always be sure to attach supports

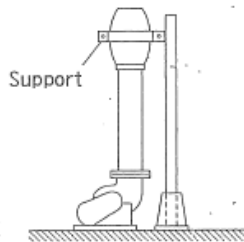

ENSURE SMOOTHNESS OF DUCTS

In the drawing below, the ducts with the profile denoted by dotted lines cause an increase in vibration and performance loss.

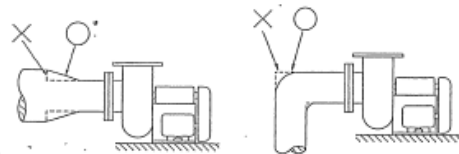

CAUTION

USE GUIDE VANES ON RIGHT-ANGLE ELBOWS

A 90° elbow causes excessive vibration and a decline in fan performance when attached to the suction side.

For a case like the one shown below use a guide vane.

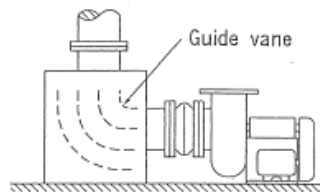

CAUTION

DRAIN THE FAN CASING

If the handled gas contains mist, vapor or dust, install a drain and make sure the casing is drained regularly.



ELECTRICAL WIRING

- 1) Wiring should comply with the electrical standards and the specifications of your local government and electric power company.
- 2) Connect the wiring temporarily to check the rotational direction of the fan. Fix the wiring properly only when the rotational direction has been confirmed. The direction of rotation should comply with the direction shown by the arrow on the motor.
- 3) Always install a ground wire.
- 4) Wiring should be done by qualified electricians.

PRECAUTIONS BEFORE STARTING OPERATIONS

Check the bearings as storage or stoppage for a long duration may result in deterioration of the bearing grease.

- 1) Check that no foreign objects or tools have been left inside peripheral machines or inside the fan casing during installation.
- 2) Be sure to check for proper rotation of the impeller as indicated by the red arrow.
- 3) To operate the fan, start it up with the damper completely closed. When the motor has attained the rated speed, open the damper slowly, and adjust to the specified gas volume.
- 4) If the fan is run at full operation outright, the motor may overload leading to a breakdown in the electrical system.
- 5) Apply grease when the bearings emit an abnormal sound.

RUNNING PRECAUTIONS



DANGER

DO NOT EXCEED THE MAXIMUM TEMPERATURE

(Max temperature stated on nameplate)

The gas temperature must not exceed the maximum value as it may result in impeller damage.

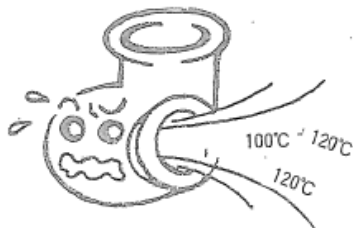

CAUTION

DO NOT EXCEED THE RATED CURRENT

Depending on the state of the gas, a surge in shaft power may cause the motor to burn out. Use an ammeter to check the current.

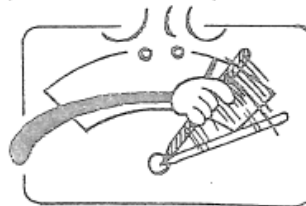



WARNING

CLOSED OPERATION FOR A LONG PERIOD IS PROHIBITED

Running the fan continuously with the damper completely closed will cause heat buildup and impeller failure.



WARNING

DO NOT RUB DUST ON THE IMPELLER

Accumulation of dust on the impeller may cause vibration and impeller failure.

Clean the impeller periodically.

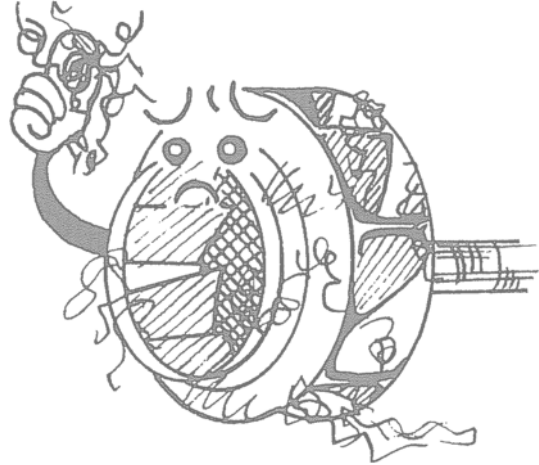

WARNING

DO NOT MOUNT ON THE FAN

Mounting or leaning against the shaft and safety guards may break them leading to a mishap.



WARNING

SWITCH OFF FAN BEFORE INSPECTING THE CASING INTERIOR

Severe bodily harm may be inflicted if the interior of the casing is inspected while the fan is running.

Switch off the fan, place an "Inspection-in-Process" tag.



Maintenance & Inspection

General maintenance and inspection is recommended once a year even if no abnormalities are observed under operating conditions.

1) Motor Vibration

Exceptionally large vibrations have a negative influence on the bearings and in worst cases could lead to breakage of the impeller.

Measure the bearing housing vibration with a vibration meter. If the registered value is higher than the standard value shown in Fig. 2, inspect the following points:

Causes of and Countermeasures for Vibration Readings Higher than Standard Values

Cause	Countermeasure
Looseness of anchor bolts	Tighten anchor bolts
Looseness of motor set bolts	Tighten motor set bolts
Imbalance of impeller due to adhesion of scales	Wash away scales thoroughly

Fig.2 Permissible Values of Vibrations on Motor Housing
JIS B 8330 (Given for Reference)

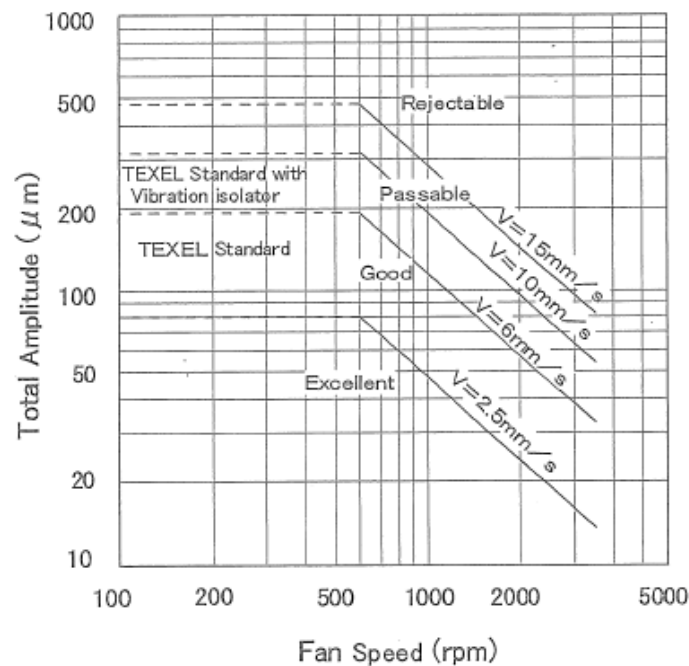

Reference: The relation between the total amplitude a (μm) and velocity of vibration v (mm/s) is as given below.

$$V = a \cdot \omega / 2 \times 10^3 = a \cdot \omega \cdot n / 6 \times 10^4 \quad \omega: \text{angular velocity} = 2\pi n / 60 \quad (\text{rad/s})$$

n : number of revolutions (rpm)

INSTRUCTIONS FOR DISMANTLING

Impeller Unit

When dismantling the impeller unit, the following procedures must be observed:

- 1) Detach the suction pipe
- 2) Next, remove the suction cone by rotating it 30° counterclockwise (see Fig.3)
- 3) To unfasten the impeller nut, turn it in the rotational direction of the impeller and detach it.
- 4) Detach the impeller.

Fig.3



Adjust match mark of the suction cone to the center of the discharge flange.

INSTRUCTIONS FOR ASSEMBLY

When assembling the impeller unit and the motor, please note that the procedures should be carried out in the reverse order of the dismantling work.

- 1) When installing the suction cone, make sure the marked reference is aligned to the center of the discharge flange.
- 2) Displaced flange bolt holes or leakage of gas at the joints may occur if fitted with the marked reference displaced.
- 3) Ensure that excessive load or torsion is not exerted on the suction cone.